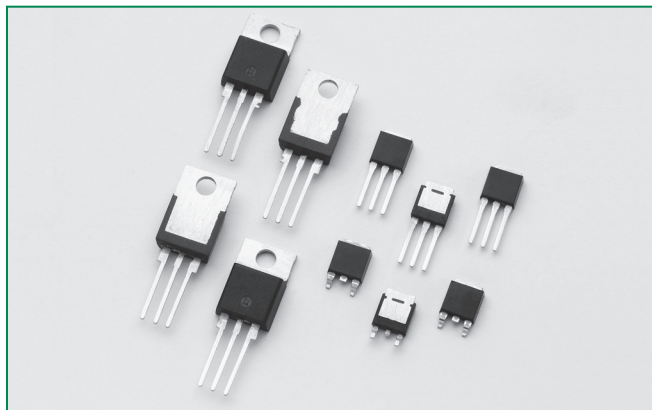

RoHS Sxx12x Series

Description

Excellent unidirectional switches for phase control applications such as heating and motor speed controls. Standard phase control SCRs are triggered with few milliamperes of current at less than 1.5V potential.

Features & Benefits

- RoHS compliant
- Glass – passivated junctions
- Voltage capability up to 1000 V
- Surge capability up to 120 A

Applications

Typical applications are capacitive discharge systems for strobe lights, nailers, staplers and gas engine ignition. Also controls for power tools, home/brown goods and white goods appliances.

Main Features

Symbol	Value	Unit
$I_{T(RMS)}$	12	A
V_{DRM}/V_{RRM}	400 to 1000	V
I_{GT}	20	mA

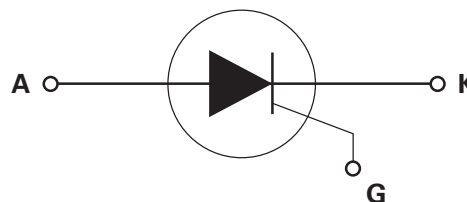
Schematic Symbol

Absolute Maximum Ratings

Symbol	Parameter	Test Conditions		Value	Unit
$I_{T(RMS)}$	RMS on-state current	Sxx12R Sxx12D Sxx12V	$T_c = 105^\circ\text{C}$	12	A
$I_{T(AV)}$	Average on-state current	Sxx12R Sxx12D Sxx12V	$T_c = 105^\circ\text{C}$	7.6	A
I_{TSM}	Peak non-repetitive surge current	single half cycle; $f = 50\text{Hz}$; $T_j(\text{initial}) = 25^\circ\text{C}$		100	A
		single half cycle; $f = 60\text{Hz}$; $T_j(\text{initial}) = 25^\circ\text{C}$		120	
I^2t	I^2t Value for fusing	$t_p = 8.3 \text{ ms}$		60	A^2s
di/dt	Critical rate of rise of on-state current	$f = 60\text{Hz}$; $T_j = 125^\circ\text{C}$		100	$\text{A}/\mu\text{s}$
I_{GM}	Peak gate current	$T_j = 125^\circ\text{C}$		2	A
$P_{G(AV)}$	Average gate power dissipation	$T_j = 125^\circ\text{C}$		0.5	W
T_{stg}	Storage temperature range			-40 to 150	$^\circ\text{C}$
T_j	Operating junction temperature range			-40 to 125	

Note: xx = voltage

Electrical Characteristics ($T_J = 25^\circ\text{C}$, unless otherwise specified)

Symbol	Test Conditions		Value	Unit	
I_{GT}	$V_D = 12\text{V}$ $R_L = 60\ \Omega$		MAX.	20	mA
V_{GT}			MIN.	1	
				MAX.	1.5
dv/dt	$V_D = V_{DRM}$; gate open; $T_J = 100^\circ\text{C}$	400V	MIN.	350	V/ μs
		600V		300	
		800V		250	
		1000V		100	
	$V_D = V_{DRM}$; gate open; $T_J = 125^\circ\text{C}$	400V		250	
		600V		225	
800V		200			
V_{GD}	$V_D = V_{DRM}$ $R_L = 3.3\ \text{k}\Omega$ $T_J = 125^\circ\text{C}$		MIN.	0.2	V
I_H	$I_T = 200\text{mA}$ (initial)		MAX.	40	mA
t_q	$I_T = 2\text{A}$; $t_p = 50\ \mu\text{s}$; dv/dt = 5V/ μs ; di/dt = 30A/ μs		MAX.	35	μs
t_{gt}	$I_G = 2 \times I_{GT}$ PW = 15 μs $I_T = 20\text{A}$		TYP.	2	μs

Static Characteristics

Symbol	Test Conditions		Value	Unit		
V_{TM}	$I_T = 24\text{A}$; $t_p = 380\ \mu\text{s}$		MAX.	1.6	V	
I_{DRM} / I_{RRM}	$V_{DRM} = V_{RRM}$	$T_J = 25^\circ\text{C}$	400 – 600V	MAX.	10	μA
			800 – 1000V		20	
		$T_J = 100^\circ\text{C}$	400 – 800V		500	
			1000V		3000	
		$T_J = 125^\circ\text{C}$	400 – 800V		1000	

Thermal Resistances

Symbol	Parameter		Value	Unit
$R_{\theta(J-C)}$	Junction to case (AC)	Sxx12R	1.5	$^\circ\text{C/W}$
		Sxx12V	1.6	
		Sxx12D	1.4	
$R_{\theta(J-A)}$	Junction to ambient	Sxx12R	40	$^\circ\text{C/W}$
		Sxx12V	70	

Note: xx = voltage

Figure 1: Normalized DC Gate Trigger Current vs. Junction Temperature

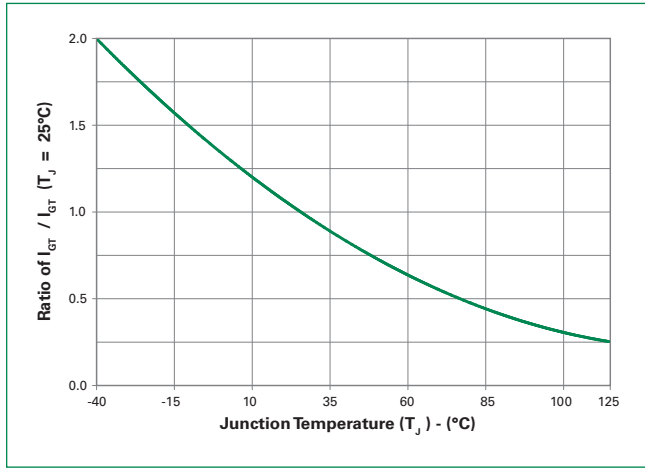

Figure 2: Normalized DC Gate Trigger Voltage vs. Junction Temperature

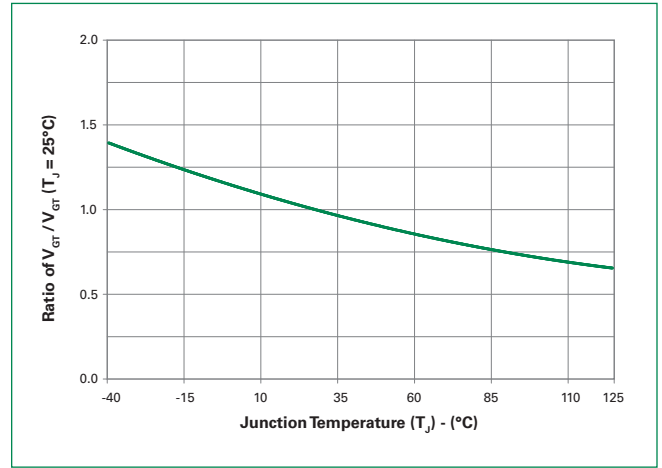

Figure 3: Normalized DC Holding Current vs. Junction Temperature

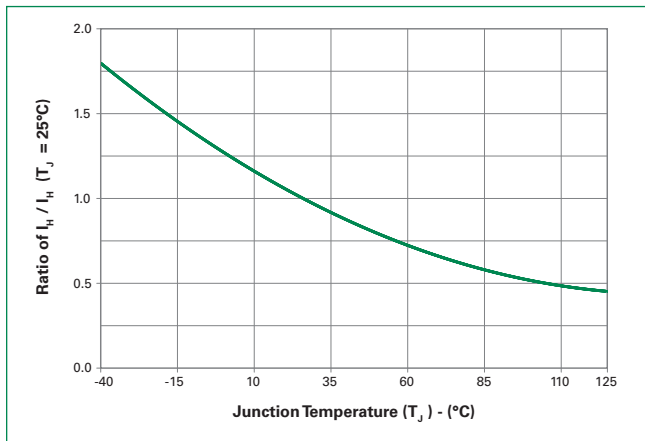

Figure 4: On-State Current vs. On-State Voltage (Typical)

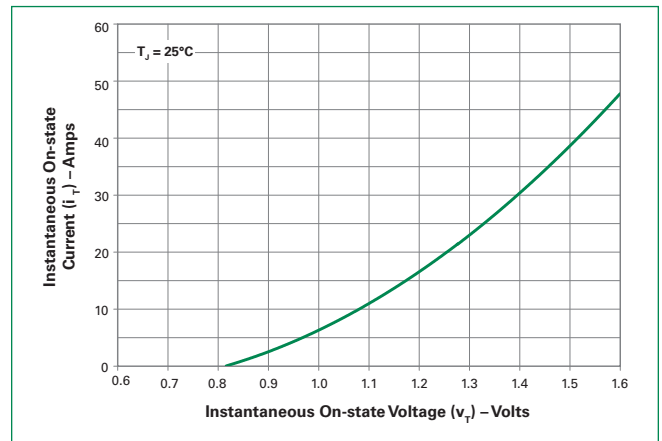
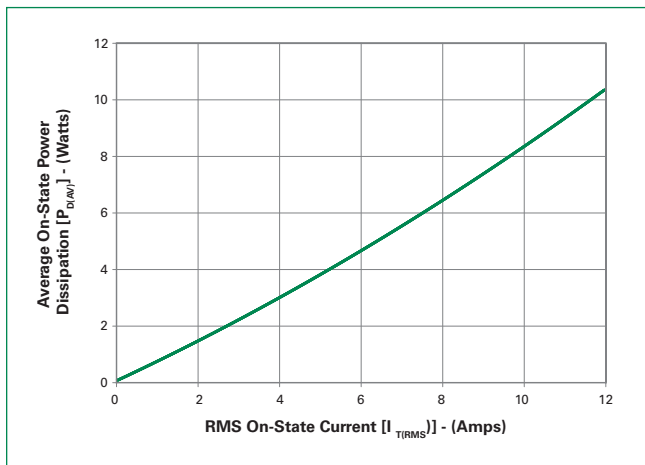

Figure 5: Power Dissipation (Typical) vs. RMS On-State Current



12A SCRs

Figure 6: Maximum Allowable Case Temperature vs. RMS On-State Current

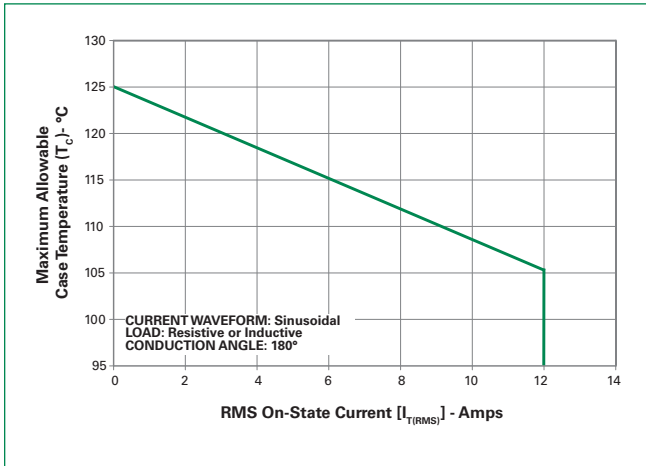

Figure 7: Maximum Allowable Case Temperature vs. Average On-State Current

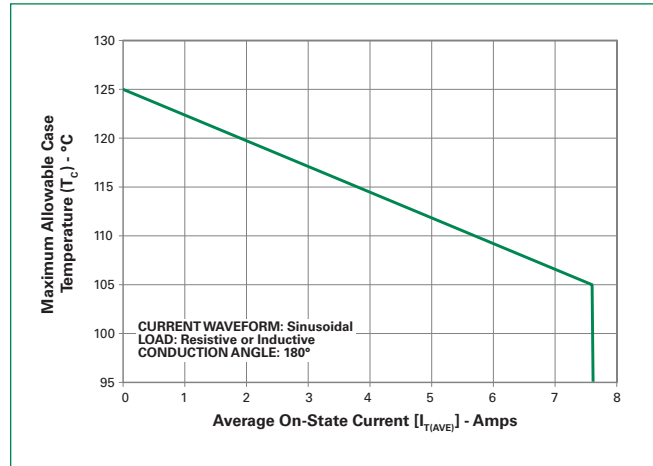

Figure 8: Maximum Allowable Ambient Temperature vs. RMS On-State Current

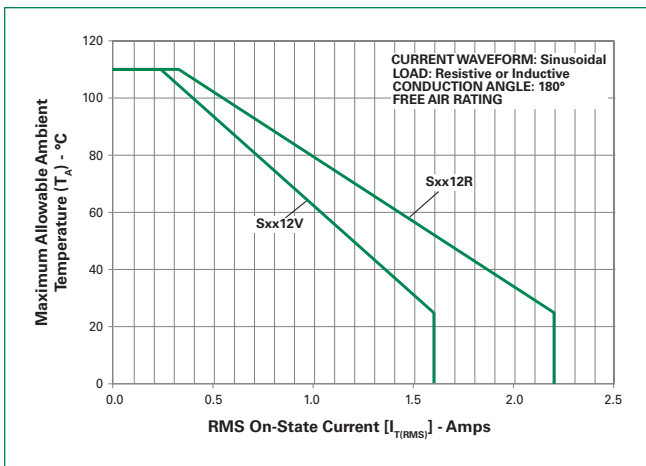
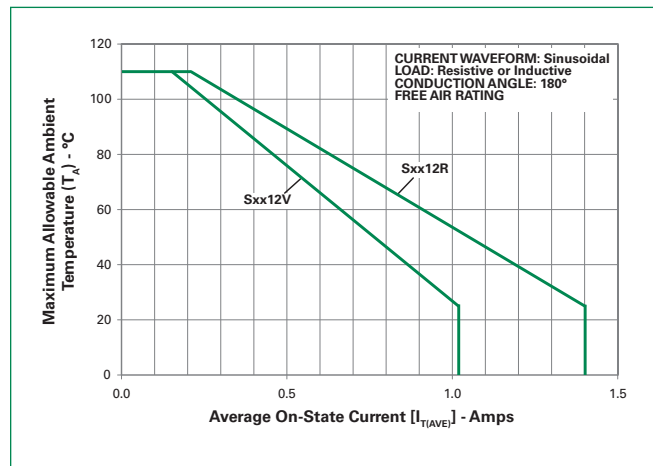

Figure 9: Maximum Allowable Ambient Temperature vs. Average On-State Current



Note: xx = voltage

Figure 10: Peak Capacitor Discharge Current

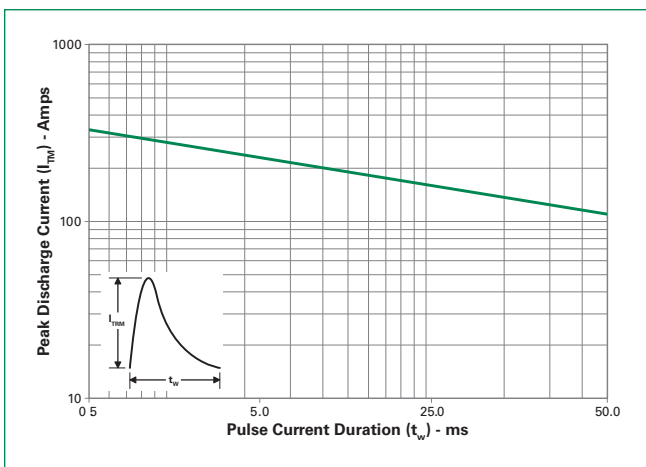

Figure 11: Peak Capacitor Discharge Current Derating

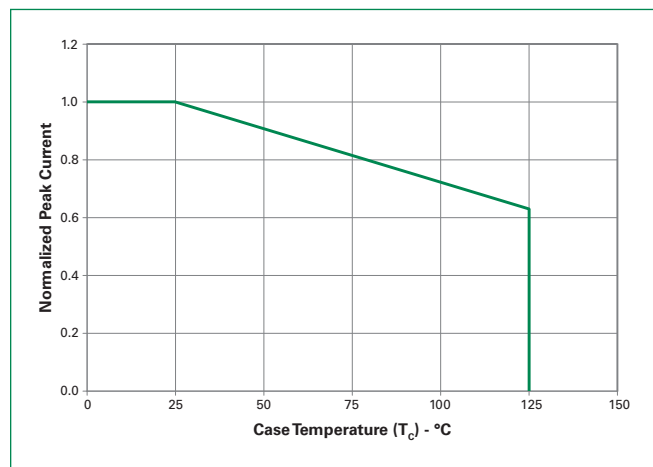
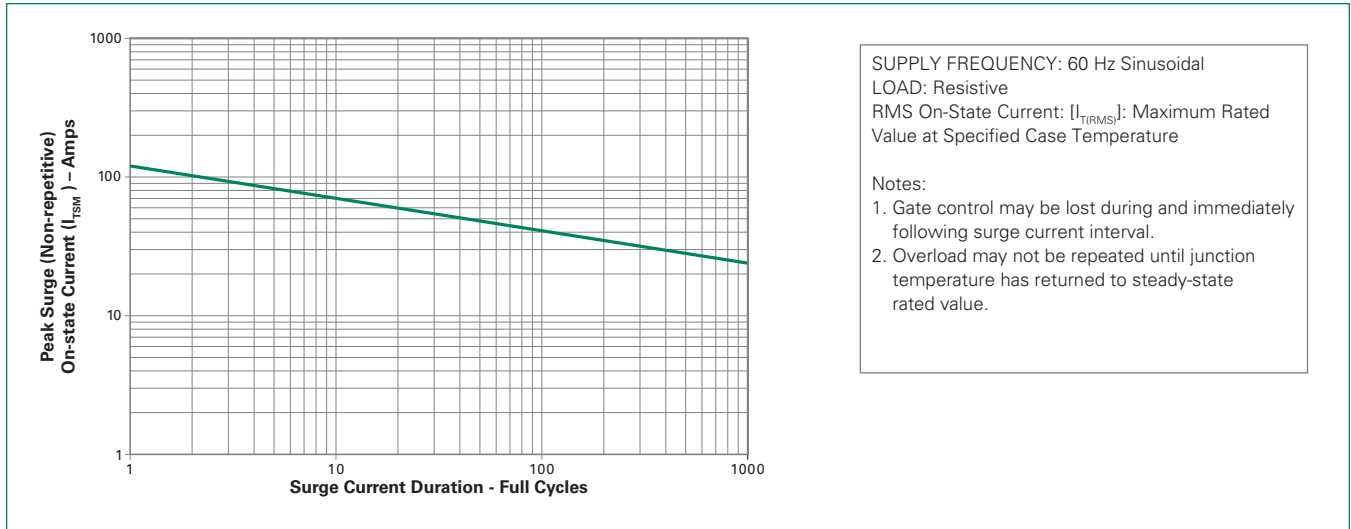
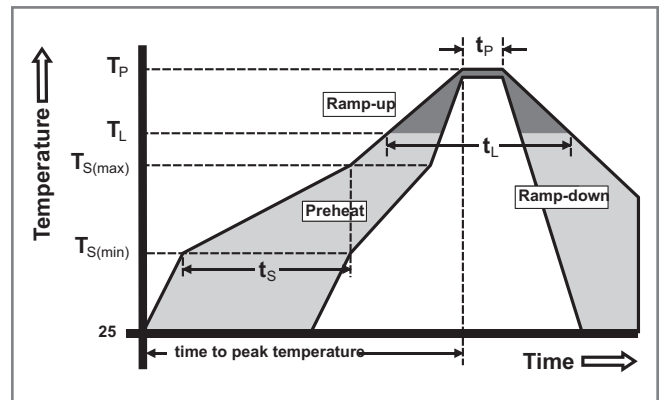

Figure 12: Surge Peak On-State Current vs. Number of Cycles



Soldering Parameters

Reflow Condition		Pb – Free assembly
Pre Heat	- Temperature Min ($T_{s(min)}$)	150°C
	- Temperature Max ($T_{s(max)}$)	200°C
	- Time (min to max) (t_s)	60 – 180 secs
Average ramp up rate (Liquidus Temp) (T_L) to peak		5°C/second max
$T_{s(max)}$ to T_L - Ramp-up Rate		5°C/second max
Reflow	- Temperature (T_L) (Liquidus)	217°C
	- Temperature (t_l)	60 – 150 seconds
Peak Temperature (T_p)		260 ^{+0/-5} °C
Time within 5°C of actual peak Temperature (t_p)		20 – 40 seconds
Ramp-down Rate		5°C/second max
Time 25°C to peak Temperature (T_p)		8 minutes Max.
Do not exceed		280°C



12A SCRs

Physical Specifications

Terminal Finish	100% Matte Tin-plated
Body Material	UL recognized epoxy meeting flammability classification 94V-0
Lead Material	Copper Alloy

Design Considerations

Careful selection of the correct device for the application's operating parameters and environment will go a long way toward extending the operating life of the Thyristor. Good design practice should limit the maximum continuous current through the main terminals to 75% of the device rating. Other ways to ensure long life for a power discrete semiconductor are proper heat sinking and selection of voltage ratings for worst case conditions. Overheating, overvoltage (including dv/dt), and surge currents are the main killers of semiconductors. Correct mounting, soldering, and forming of the leads also help protect against component damage.

Environmental Specifications

Test	Specifications and Conditions
AC Blocking	MIL-STD-750, M-1040, Cond A Applied Peak AC voltage @ 125°C for 1008 hours
Temperature Cycling	MIL-STD-750, M-1051, 100 cycles; -40°C to +150°C; 15-min dwell-time
Temperature/Humidity	EIA / JEDEC, JESD22-A101 1008 hours; 320V - DC: 85°C; 85% rel humidity
High Temp Storage	MIL-STD-750, M-1031, 1008 hours; 150°C
Low-Temp Storage	1008 hours; -40°C
Thermal Shock	MIL-STD-750, M-1056 10 cycles; 0°C to 100°C; 5-min dwell-time at each temperature; 10 sec (max) transfer time between temperature
Autoclave	EIA / JEDEC, JESD22-A102 168 hours (121°C at 2 ATMs) and 100% R/H
Resistance to Solder Heat	MIL-STD-750 Method 2031
Solderability	ANSI/J-STD-002, category 3, Test A
Lead Bend	MIL-STD-750, M-2036 Cond E

Dimensions — TO-220AB (R-Package) — Non-Isolated Mounting Tab Common with Center Lead

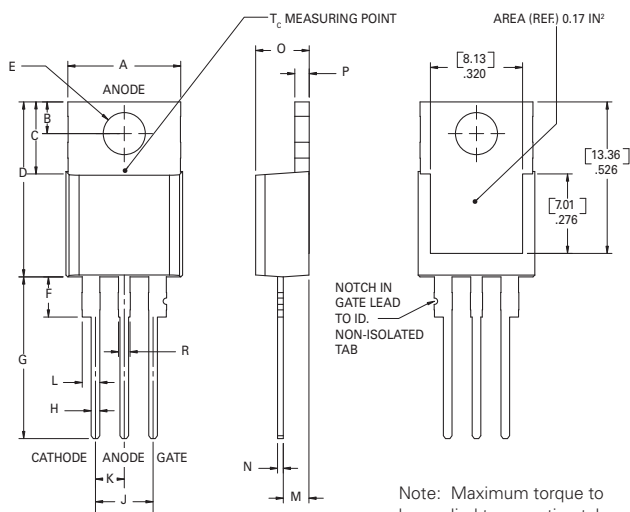

Dimension	Inches		Millimeters	
	Min	Max	Min	Max
A	0.380	0.420	9.65	10.67
B	0.105	0.115	2.67	2.92
C	0.230	0.250	5.84	6.35
D	0.590	0.620	14.99	15.75
E	0.142	0.147	3.61	3.73
F	0.110	0.130	2.79	3.30
G	0.540	0.575	13.72	14.61
H	0.025	0.035	0.64	0.89
J	0.195	0.205	4.95	5.21
K	0.095	0.105	2.41	2.67
L	0.060	0.075	1.52	1.91
M	0.085	0.095	2.16	2.41
N	0.018	0.024	0.46	0.61
O	0.178	0.188	4.52	4.78
P	0.045	0.060	1.14	1.52
R	0.038	0.048	0.97	1.22

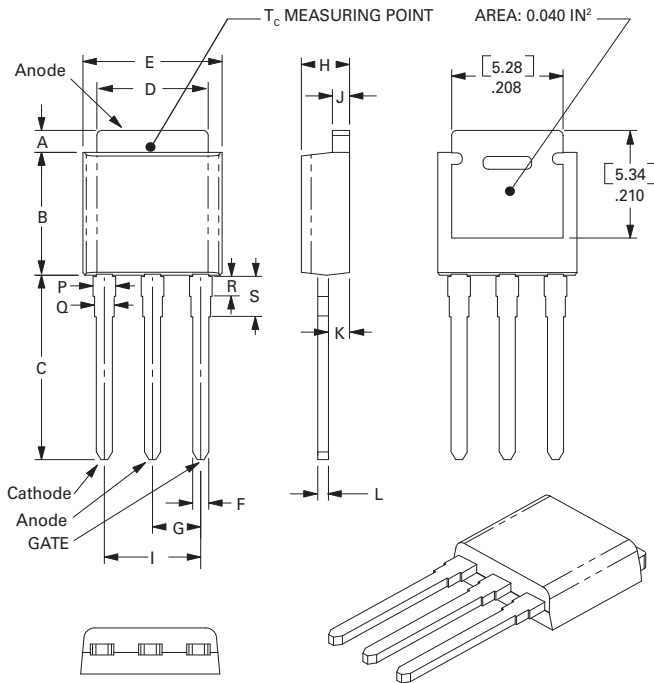
Dimensions — TO-251AA (V/I-Package) — V/I-PAK Through Hole

Dimension	Inches			Millimeters		
	Min	Typ	Max	Min	Typ	Max
A	0.040	0.044	0.050	1.02	1.11	1.27
B	0.235	0.242	0.245	5.97	6.15	6.22
C	0.350	0.361	0.375	8.89	9.18	9.53
D	0.205	0.208	0.213	5.21	5.29	5.41
E	0.255	0.262	0.265	6.48	6.66	6.73
F	0.027	0.031	0.033	0.69	0.80	0.84
G	0.087	0.090	0.093	2.21	2.28	2.36
H	0.085	0.092	0.095	2.16	2.34	2.41
I	0.176	0.180	0.184	4.47	4.57	4.67
J	0.018	0.020	0.023	0.46	0.51	0.58
K	0.038	0.040	0.044	0.97	1.01	1.12
L	0.018	0.020	0.023	0.46	0.52	0.58
P	0.042	0.047	0.052	1.06	1.20	1.32
Q	0.034	0.039	0.044	0.86	1.00	1.11
R	0.034	0.039	0.044	0.86	1.00	1.11
S	0.074	0.079	0.084	1.86	2.00	2.11

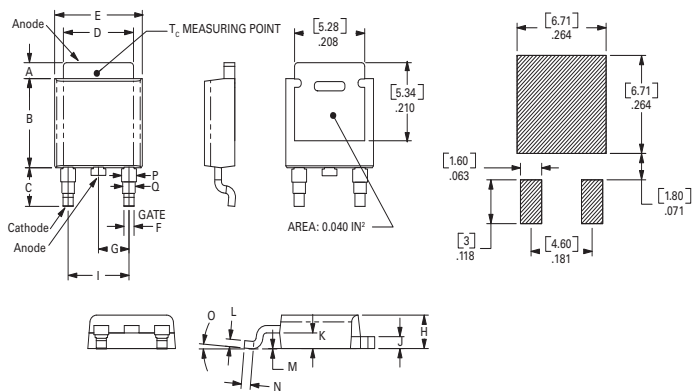
Dimensions — TO-252AA (D-Package) — D-PAK Surface Mount

Dimension	Inches			Millimeters		
	Min	Typ	Max	Min	Typ	Max
A	0.040	0.043	0.050	1.02	1.09	1.27
B	0.235	0.243	0.245	5.97	6.16	6.22
C	0.106	0.108	0.113	2.69	2.74	2.87
D	0.205	0.208	0.213	5.21	5.29	5.41
E	0.255	0.262	0.265	6.48	6.65	6.73
F	0.027	0.031	0.033	0.69	0.80	0.84
G	0.087	0.090	0.093	2.21	2.28	2.36
H	0.085	0.092	0.095	2.16	2.33	2.41
I	0.176	0.179	0.184	4.47	4.55	4.67
J	0.018	0.020	0.023	0.46	0.51	0.58
K	0.038	0.040	0.044	0.97	1.02	1.12
L	0.018	0.020	0.023	0.46	0.51	0.58
M	0.000	0.000	0.004	0.00	0.00	0.10
N	0.021	0.026	0.027	0.53	0.67	0.69
O	0°	0°	5°	0°	0°	5°
P	0.042	0.047	0.052	1.06	1.20	1.32
Q	0.034	0.039	0.044	0.86	1.00	1.11

Product Selector

Part Number	Voltage				Gate Sensitivity	Type	Package
	400V	600V	800V	1000V			
Sxx12R	X	X	X	X	20mA	Sensitive SCR	TO-220R
Sxx12V	X	X	X	X	20mA	Standard SCR	TO-251
Sxx12D	X	X	X	X	20mA	Standard SCR	TO-252

Note: xx = voltage

Packing Options

Part Number	Marking	Weight	Packing Mode	Base Quantity
Sxx12R	Sxx12R	2.2 g	Bulk	500
Sxx12RTP	Sxx12R	2.2 g	Tube	500 (50 per tube)
Sxx12DTP	Sxx12D	0.3 g	Tube	750 (75 per tube)
Sxx12DRP	Sxx12D	0.3 g	Embossed Carrier	2500
Sxx12VTP	Sxx12V	0.4 g	Tube	750 (75 per tube)

Note: xx = Voltage

TO-252 Embossed Carrier Reel Pack (RP) Specifications

Meets all EIA-481-2 Standards

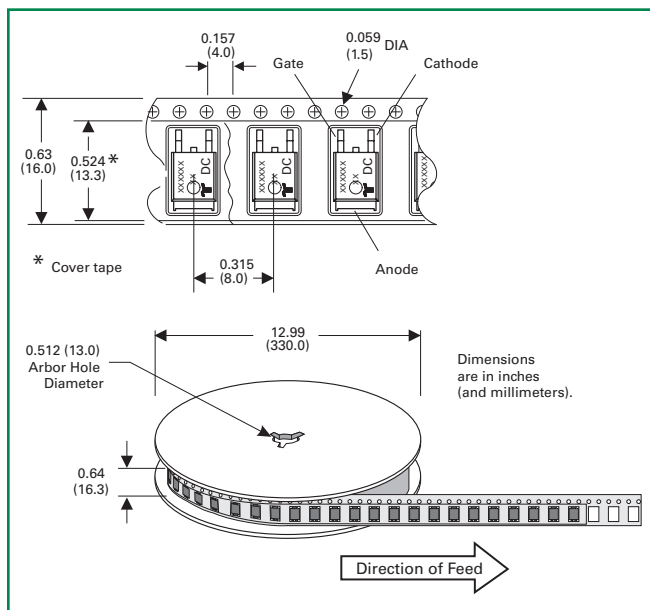

Part Marking System

TO-220AB (R Package)

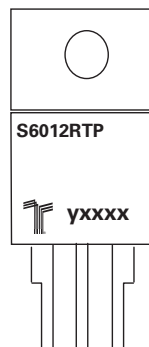

TO-251AA – (V Package)

TO-252AA – (D Package)

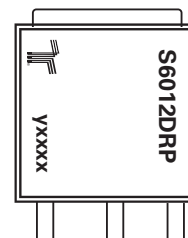

Part Numbering System

